

Dell EMC PowerEdge R650

Technical Guide

Notes, cautions, and warnings

 **NOTE:** A NOTE indicates important information that helps you make better use of your product.

 **CAUTION:** A CAUTION indicates either potential damage to hardware or loss of data and tells you how to avoid the problem.

 **WARNING:** A WARNING indicates a potential for property damage, personal injury, or death.

Contents

Chapter 1: System overview.....	6
Key workloads.....	6
New technologies.....	7
Chapter 2: System features and generational comparison.....	8
Chapter 3: Chassis views and features.....	10
Chassis views.....	10
Front view of the system	10
Rear view of the system	11
Inside the system.....	11
Quick Resource Locator.....	12
Chapter 4: Processor.....	14
Processor features.....	14
Supported processors.....	14
Chapter 5: Memory subsystem.....	16
Supported memory.....	16
Memory speed.....	16
Chapter 6: Storage.....	17
Storage controllers.....	17
Supported drives.....	17
Internal storage	18
External storage	18
Chapter 7: Networking.....	19
Overview.....	19
Supported OCP cards.....	19
OCP NIC 3.0 and rack network daughter card comparison.....	20
SNAP I/O Support.....	20
SNAP Input Output value proposition.....	20
Chapter 8: PCIe subsystem.....	21
PCIe risers.....	21
Chapter 9: Power, thermal, and acoustics.....	23
Power.....	23
Power Supply Units.....	23
PSU rating.....	24
Thermal.....	25
Thermal design.....	25

- Thermal restrictions..... 26
- Multi Vector cooling 2.0 26
- Acoustics..... 27
 - Acoustical design..... 27
 - PowerEdge R650 acoustics..... 28
 - Acoustical performance..... 30
 - PowerEdge R650 acoustical dependencies..... 31
 - Methods to reduce acoustical output of the R650..... 32
- Chapter 10: Rack information..... 33**
 - Static rails..... 33
 - Sliding rails..... 34
- Chapter 11: Supported operating systems..... 36**
- Chapter 12: Dell EMC OpenManage systems management..... 37**
 - Server and Chassis Managers..... 38
 - Dell EMC consoles..... 38
 - Automation Enablers..... 38
 - Integration with third-party consoles..... 38
 - Connections for third-party consoles..... 38
 - Dell EMC Update Utilities..... 38
 - Dell resources..... 38
- Chapter 13: Dell Technologies Services 40**
 - Dell EMC ProDeploy Enterprise Suite 40
 - Dell EMC ProDeploy Plus..... 41
 - Dell EMC ProDeploy..... 41
 - Basic Deployment..... 41
 - Dell EMC Server Configuration Services..... 41
 - Dell EMC Residency Services..... 41
 - Dell EMC Remote Consulting Services..... 41
 - Dell EMC Data Migration Service..... 41
 - Dell EMC ProSupport Enterprise Suite..... 41
 - Dell EMC ProSupport Plus for Enterprise..... 42
 - Dell EMC ProSupport for Enterprise..... 42
 - Dell EMC ProSupport One for Data Center..... 43
 - ProSupport for HPC..... 43
 - Support Technologies..... 44
 - Dell Technologies Education Services..... 45
 - Dell Technologies Consulting Services..... 45
 - Dell EMC Managed Services..... 45
- Chapter 14: Appendix A. Additional specifications..... 46**
 - Chassis dimension..... 46
 - Chassis weight..... 46
 - Video specifications..... 47
 - USB Ports..... 47
 - PSU rating..... 48

Environmental Specifications..... 49

 Thermal restrictions..... 49

Chapter 15: Appendix B. Standards compliance..... 50

Chapter 16: Appendix C Additional resources..... 51

System overview

The Dell EMC™ PowerEdge™ R650 is Dell EMC's latest 1U 2-socket designed to run complex workloads using highly scalable memory, I/O, and network options. The system features the 3rd Generation Intel® Xeon® Processor Scalable family, with up to 32 DDR4 DIMMs, up to 3 PCI Express® Gen4 enabled expansion slots, and a choice of embedded NIC technologies.

Topics:

- [Key workloads](#)
- [New technologies](#)

Key workloads

The PowerEdge R650 is a dense, general purpose platform that is ready to run any workload found within a customer's datacenter. The following table lists some of these workloads and the situations wherein the PowerEdge R650 is a good fit.

Table 1. Key workloads

Workload	PowerEdge R650 is best for
General data center standardization	Customers with a wide range of workloads requiring a single server model to handle them all. Flexible configuration options allow these to match the performance needed for the most demanding workloads
Virtualization & cloud applications	High density virtualization Cloud-native applications Medium local storage requirements
Virtual desktop infrastructure (VDI)	VDI deployments requiring low end GPUs Low-medium local storage capacity
Database & analytics	Large traditional or in-memory databases Low-medium local storage capacity Persistent memory
High performance computing (HPC)	HPC that requires large memory capacity High performance CPU support
Software defined storage (SDS) build-out	High performance SDS node Low-medium local storage capacity Persistent memory
High frequency trading	Requires highest CPU frequency Highest density form factor

New technologies

Table 2. New Technologies

Technology	Detailed Description
3rd Generation Intel® Xeon® Processor Scalable Family	Consult the supported processors section for specific SKU details. <ul style="list-style-type: none"> ● 10 nm process technology ● 3x Intel® Ultra Path Interconnect (UPI) per CPU at 10.4 GT/s or 11.2 GT/s ● 64 PCIe Gen4 lanes at 16 GT/s ● Up to 40 cores per socket ● Up to 3.6 GHz ● Max TDP: 270W
3200 MT/s DDR4 memory	<ul style="list-style-type: none"> ● Max 16 DIMMs per CPU ● Supports DDR4 RDIMM, LRDIMM, 3DS DIMM and with ECC up to 3200MT/s
Persistent memory	<ul style="list-style-type: none"> ● Supports DDR4 Intel Persistent Memory 200 series up to 3200 MT/s, max 8x 512GB Intel Persistent Memory 200 series DIMMs per CPU.
Flex IO	<ul style="list-style-type: none"> ● LOM board, 2x1 Gb with BCM5720 LAN controller ● Standard rear IO with 1 Gb dedicated management network port, USB 3.0 x 1, USB 2.0 x 1, and VGA port ● Serial port option with standard RIO board ● OCP Mezz 3.0 (supported by x8 PCIe lanes) ● LC rear IO with 1 Gb dedicated management network port, USB 3.0 x 1, USB 2.0 x 1 ● Serial port or VGA port option with LC RIO board
Dedicated PERC	<ul style="list-style-type: none"> ● Front storage module PERC with front PERC10.5 & PERC11
Software RAID	<ul style="list-style-type: none"> ● OS RAID/S150
Power supplies	<ul style="list-style-type: none"> ● 60 mm dimension is the new PSU form factor on 15G design ● Platinum 800W AC Mixed Mode ● Titanium 1100W AC Mixed Mode ● Platinum 1400W AC Mixed Mode ● 1100W - 48V DC

System features and generational comparison

The following table shows the comparison between the PowerEdge R650 with the PowerEdge R640:

Table 3. Features compared to previous version

Feature	PowerEdge R650	PowerEdge R640
CPU	2 x 3rd Generation Intel® Xeon® Processor Scalable Family	2 x 2nd Generation Intel® Xeon® Processor Scalable Family
CPU interconnect	Intel Ultra Path Interconnect (UPI)	Intel Ultra Path Interconnect (UPI)
Memory	32 x DDR4 RDIMM, LRDIMM 16 x PMem (Intel Optane Persistent Memory 200 Series)	24 x DDR4 RDIMM, LRDIMM 12 x NVDIMM 12 x PMem (Intel Optane Apache Pass)
Storage drives	3.5 inches, 2.5 inches- 12 Gb SAS, 6 Gb SATA, NVMe	3.5 inches, 2.5 inches- 12 Gb SAS, 6 Gb SATA, NVMe
Storage controllers	Adapters: HBA355E, H840 PERC: HBA355i, H345, H355, H745, H755, H755N BOSS- S1 adapter BOSS S2 SW RAID: S150	Adapters: HBA330, H330, H730P, H740P, H840, 12G SAS HBA Mini Mono: HBA330, H330, H730P, H740P SW RAID: S140
PCIe SSD	Up to 10+2 (10 x direct attach in front, and 2 x direct attach in rear)	Up to 10 (8 x direct attach, 2 x from PCIe bridge card)
PCIe slots	Max 3 PCIe 4.0	Max 3 PCIe 3.0
LOM	2 x 1 Gb	NA
Networking	OCP 3.0 (x8 PCIe)	rNDC
Rack height	1U	1U
Power supplies	100~240 V AC/240 V DC: 800 W, 1100 W, 1400 W DC - 48 V ~- 60 V :1100 W	AC (Platinum): 495 W, 750 W, 1100 W, 1600W, 2000W, 2400W AC (Titanium): 750 W DC: 1100 W Mix Mode/HVDC: 750 W, 1100 W
System management	LC 4.x, OpenManage, QuickSync2.0, Digital License Key, iDRAC Direct (dedicated micro-USB port), Easy Restore	LC 3.x, OpenManage, QuickSync 2.0, OMPC3, Digital License Key, iDRAC Direct (dedicated micro-USB port), Easy Restore, vFlash
Internal GPU	Up to 3 x 75 W (SW)	Up to 3 x 70 W (SW)
Availability	Hot-plug drives	Hot-plug drives

Table 3. Features compared to previous version (continued)

Feature	PowerEdge R650	PowerEdge R640
	Hot-plug redundant cooling Hot-plug redundant power supplies Hot-plug BOSS S2 IDSDM	Hot-plug redundant cooling Hot-plug redundant Power supplies BOSS IDSDM

Chassis views and features

Topics:

- Chassis views

Chassis views

Front view of the system

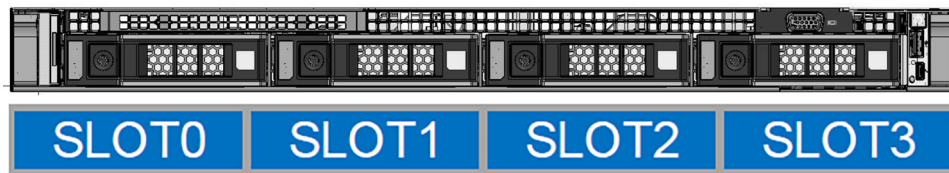

Figure 1. Front view of the R650, 4x 3.5 inches Chassis

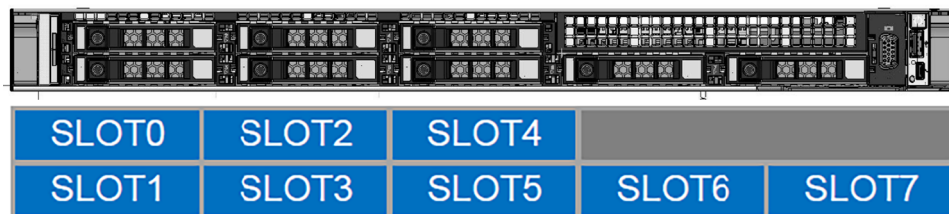

Figure 2. Front view of the R650, 8x 2.5 inches SAS/SATA Chassis

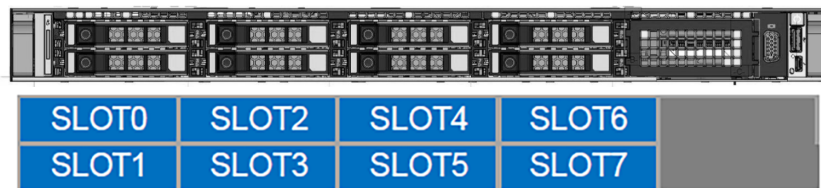

Figure 3. Front view of the R650, 8x 2.5 inches NVMe Chassis

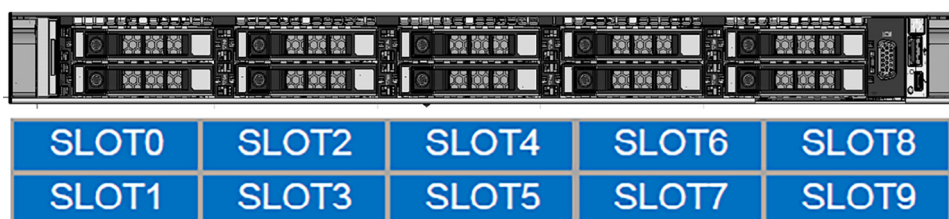

Figure 4. Front View of the R650, 10x 2.5 inches SAS/SATA or NVMe

Rear view of the system



Figure 5. Rear view of the R650 with 3x LP PCIe Gen4 slots and Hot-plug BOSS



Figure 6. Rear view of the R650 with 2x 2.5 inches Storage drives, 1x LP PCIe Gen4 slot and Hot-plug BOSS



Figure 7. Rear view of the R650 with 2x FH PCIe Gen4 slots and Hot-plug BOSS without rear storage

Inside the system

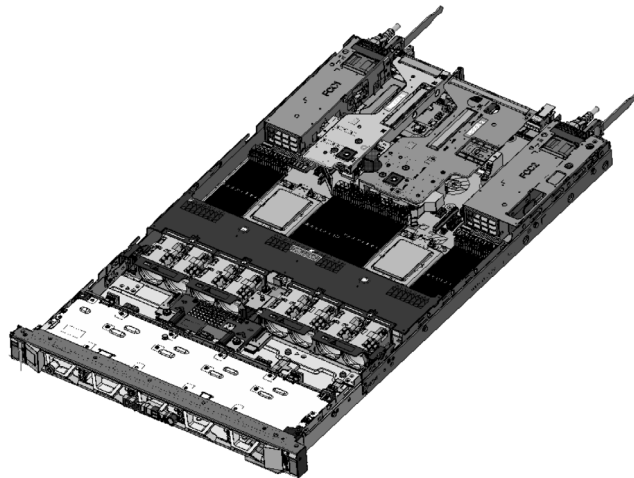

Figure 8. Inside the system, R650 with 3x LP PCIe Gen 4 slots

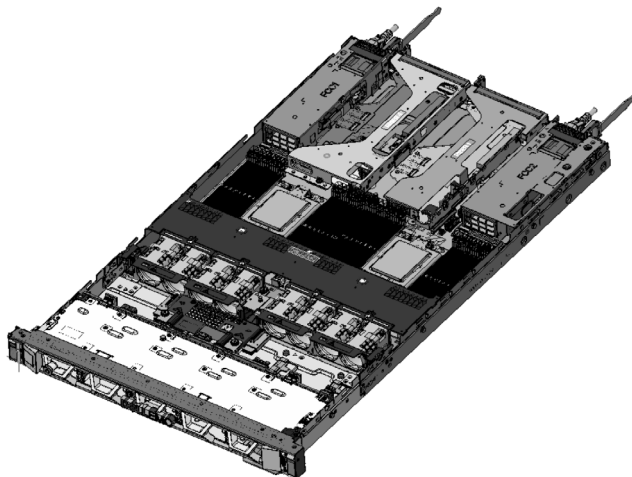

Figure 9. Inside the system, R650 with 2x FH PCIe Gen4 slots

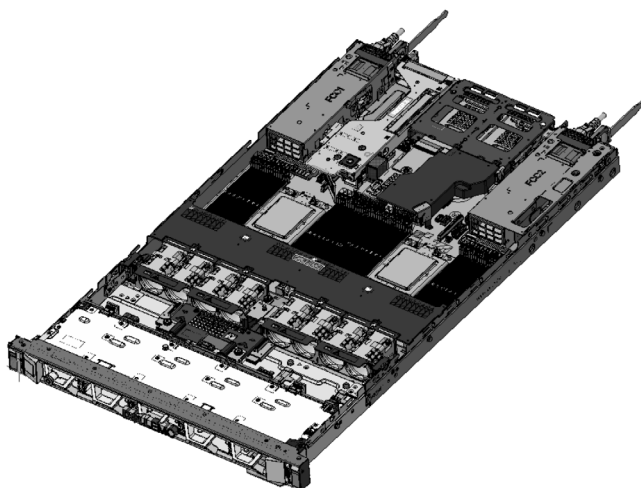

Figure 10. Inside the system, R650 with 2x Rear drives and 1 PCIe Gen4 slot

Quick Resource Locator

The QRL on everything (SILs, GSG, Installation and Service Manual except on the EST) is a generic QRL for R650 that leads to a webpage for that product. That webpage has links for things like setup and service videos, iDRAC manual, and other things that apply to the platform. The QRL on the EST is unique and specific to that service tag and will contain the Service Tag number and the iDRAC password. The label and the QRL code within it are printed on demand at the L10 factories. This QRL links to a webpage that shows the exact configuration as built for that customer, and the specific warranty purchased. It is one click away from the same content of generic information that applies to R650 that is available in the other QRLs.



Figure 11. R650 Quick Resource Locator

Processor



Topics:

- [Processor features](#)
- [Supported processors](#)

Processor features

The 3rd Generation Xeon Scalable Processor stack is next generation data center processor offering with the latest features, increased performance, and incremental memory options. This latest generation Xeon Scalable processor will support usages from entry designs based on Intel Xeon silver processors to advanced capabilities offered in new Intel Xeon platinum processor.

The following lists the features and functions included in the upcoming 3rd Generation Intel Xeon Scalable Processor offering:

- Faster UPI with 3 Intel Ultra Path Interconnect (Intel UPI) at 11.2 GT/s (supported in gold and platinum options).
- More, faster I/O with PCI Express 4 and up to 64 lanes (per socket) at 16 GT/s.
- Enhanced memory performance with support for up to 3200 MT/s DIMMs (2 DPC).
- Increased memory capacity with up to 8 channels and up to 256 GB DDR4 DIMM support.

Breakthrough system memory with Intel Optane persistent memory 200 series (up to 512 GB modules), up to 6 TB of total system memory per socket DDR+PMM.

Supported processors

Table 4. Supported Processors for R650

Processor	Frequency (GHz)	Cores/ Threads	Cache (MB)	Max Memory speed (MT/s)	Turbo	TDP (W)
8380	2.3	40/80	60	3200	Yes	270
8368Q	2.6	38/76	57	3200	Yes	270
8368	2.4	38/76	57	3200	Yes	270
8362	2.8	32/64	48	3200	Yes	265
8360Y	2.4	36/72	54	3200	Yes	250
8358	2.6	32/64	48	3200	Yes	250
8358P	2.6	32/64	48	3200	Yes	240
8352Y	2.2	32/64	48	3200	Yes	205
8352V	2.1	36/72	54	3200	Yes	195
8352S	2.2	32/64	48	3200	Yes	205
8352M	2.3	32/64	48	3200	Yes	185
8351N	2.4	36/72	54	2933	Yes	225
6354	3	18/36	39	3200	Yes	205
6348	2.6	28/56	42	3200	Yes	235

Table 4. Supported Processors for R650 (continued)

Processor	Frequency (GHz)	Cores/ Threads	Cache (MB)	Max Memory speed (MT/s)	Turbo	TDP (W)
6346	3.1	16/32	36	3200	Yes	205
6338	2	32/64	48	3200	Yes	205
6338N	2.2	32/64	48	2667	Yes	185
6330	2	28/56	42	3200	Yes	205
6330N	2.2	28/56	42	2667	Yes	165
6314U	2.3	32/64	48	3200	Yes	205
6312U	2.4	24/48	36	3200	Yes	185
6342	2.8	24/48	36	3200	Yes	230
6334	3.6	8/16	18	3200	Yes	165
6336Y	2.4	24/48	36	3200	Yes	185
6326	2.9	16/32	24	3200	Yes	185
5317	3	12/24	18	2933	Yes	150
5320	2.2	26/52	39	2933	Yes	185
5315Y	3.2	8/16	12	2933	Yes	140
5318Y	2.1	24/48	36	2933	Yes	165
4310	2.1	12/24	18	2666	Yes	120
4316	2.3	20/40	30	2666	Yes	150
4314	2.4	16/32	24	2666	Yes	135
4309Y	2.8	8/16	12	2666	Yes	105

i NOTE:

- 8368Q requires liquid cooling
- 6314U, 6312U and 8351N are supported in 1S configurations only.
- 4310, 4316, and 4309Y do not support Intel Optane Persistent Memory.

Memory subsystem

The PowerEdge R650 supports up to 32 DIMMs, with maximum capacity around 10 TB per system for 8 x 512 GB Intel Optane Persistent Memory 200 Series and 8 x 256 GB LRDIMM connected to per processor and speeds of up to 3200 MT/s.

The PowerEdge R650 supports registered (RDIMMs) and load reduced DIMMs (LRDIMMs) which use a buffer to reduce memory loading and provide greater density, allowing for the maximum platform memory capacity. Unbuffered DIMMs (UDIMMs) are not supported.

For detailed Intel Optane Persistent Memory 200 Series matrix support, please refer the tables below.

Topics:

- [Supported memory](#)
- [Memory speed](#)

Supported memory

The table below lists the memory technologies supported by the platform.

Table 5. Memory technology

Feature	PowerEdge R650 (DDR4)
DIMM type	RDIMM
	LRDIMM
	Intel Optane Persistent Memory 200 Series
Transfer speed	3200 MT/s
	2933 MT/s
	2666 MT/s
Voltage	1.2 V

Memory speed

The number of DIMMs per channel (DPC) does affect the operating memory bus speeds.

Table 6. DIMM performance details

DIMM type	DIMM ranking	Capacity	DIMM rated voltage, Speed (MT/s)	Operating speed (MT/s)	
				1 DPC	2 DPC
RDIMM	1R	8 GB	DDR4 (1.2 V), 3200	3200	3200
RDIMM	2R	16 GB, 32 GB, 64 GB	DDR4 (1.2 V), 3200	3200	3200
LRDIMM	4R	128 GB	DDR4 (1.2 V), 3200	3200	3200
	8 R	256 GB	DDR4 (1.2 V), 3200	3200	3200

Storage

Topics:

- [Storage controllers](#)
- [Supported drives](#)
- [Internal storage](#)
- [External storage](#)

Storage controllers

Dell's RAID controller options offer performance improvements, including the fPERC solution. fPERC provides a base RAID HW controller without consuming a PCIe slot by using a small form factor and high-density connector to the base planar.

15G PERC Controller offerings will be a heavy leverage of 14G PERC family. The Value and Value Performance levels will carry over to 15G from 14G. New to 15G, is the Harpoon-based Premium Performance tier offering. This high-end offering will drive IOPs performance and enhanced SSD performance.

Table 7. PERC series controller offerings

Performance Level	Controller & Description
Value Performance	S150 (SATA, NVMe) SW RAID SATA, NVMe
Value	H345, H355, HBA355I/E (Internal/External)
Value Performance	H745, H755, H755N
Premium Performance	H840

Supported drives

The table shown below lists the internal drives supported by the PowerEdge R650.

Table 8. Supported Drives

Form Factor	Type	Speed	Rotational Speed	Capacities
3.5 inches	SATA	6 Gb	7.2 K	2 TB, 4 TB, 8 TB, 12 TB, 16 GB, 18 TB
3.5 inches	SAS	12 Gb	7.2 K	2 TB, 4 TB, 8 TB, 12 TB, 16 TB, 18 TB
2.5 inches	SATA	6 Gb	SSD	240 GB, 480 GB, 960 GB, 1.92 TB, 3.84 TB
2.5 inches	SAS	12 Gb	10 K	600 GB, 1.2 TB, 2.4 TB
2.5 inches	SAS	12 Gb	15 K	900 GB
2.5 inches	SAS	12 Gb	SSD	400 GB, 480 GB, 800 GB, 960 GB, 1.6 TB, 1.92 TB, 3.84 TB, 6.4 TB, 7.68 TB 12.8 TB, 15.36 TB
M.2	SATA	6 Gb	SSD	240 GB, 480 GB
uSD	NA	NA	uSD	16 GB, 32 GB, 64 GB

Table 8. Supported Drives (continued)

Form Factor	Type	Speed	Rotational Speed	Capacities
2.5 inches	NVMe	Gen4	SSD	960 GB, 1.6 TB, 1.92 TB, 3.2 TB, 3.84 TB, 6.4 TB, 7.68 TB
2.5 inches	NVMe	Gen4	SSD	375 GB, 400 GB, 750 GB, 800 GB, 960 GB, 1.6 TB, 1.92 TB, 3.2 TB, 3.84 TB, 6.4 TB, 7.68 TB

Internal storage

The PowerEdge R650 supports the following internal storage configuration.

- 4 x 3.5-inch (SAS/SATA)
- 4 x 3.5-inch (Chipset SATA)
- 4 x 3.5-inch (SAS/SATA) + 2 x 2.5-inch (SAS/SATA or NVMe)
- 8 x 2.5-inch (SAS/SATA, NVMe, or NVMe RAID)
- 10 x 2.5-inch (SAS/SATA or with 4 universal)
- 10 x 2.5-inch (SAS/SATA) + 2 x 2.5-inch (SAS/SATA)
- 10 x 2.5-inch (NVMe)
- 10 x 2.5-inch (NVMe) + 2 x 2.5-inch (NVMe)
- 10 x 2.5-inch (SAS/SATA or with 2 universal) - 1 socket only

External storage

The PowerEdge R650 supports the external storage device types listed in the table below.

Table 9. Support external storage devices

Device type	Description
External tape	Supports connection to external USB tape products
NAS/IDM appliance software	Supports NAS software stack
JBOD	Supports connection to 12 Gb MD14xx and ME484 JBODs RBOD Supports connection to 12 Gb ME40xx series

Networking

Topics:

- [Overview](#)
- [Supported OCP cards](#)
- [SNAP I/O Support](#)

Overview

PowerEdge offers a wide variety of options to get information moving to and from our servers. Industry best technologies are chosen, and systems management features are added by our partners to firmware to tie in with iDRAC and Lifecycle Controller. These adapters are rigorously validated for worry-free, fully supported use in our servers.

Supported OCP cards

Table 10. Supported OCP cards

Form factor	DPN	Vendor	Port type	Port speed	Port count
OCP 3.0	T6HR8	Emulex (Broadcom)	BT	10 GbE	2
OCP 3.0	CP610	Emulex (Broadcom)	V2	10 GbE	2
OCP 3.0	KHCTP	Emulex (Broadcom)	V2	25 GbE	2
OCP 3.0	X1KRF	Emulex (Broadcom)	S28	25 GbE	4
OCP 3.0	G9XC9	Emulex (Broadcom)	BT	1 GbE	4
OCP 3.0	YJYK1	Intel	SF+	10 GbE	2
OCP 3.0	VMFKR	Intel	BT	10 GbE	2
OCP 3.0	50RV4	Intel	BT	10 GbE	4
OCP 3.0	VF81P	Intel	SF+	10 GbE	4
OCP 3.0	WW2NX	Intel	BT	1 GbE	4
OCP 3.0	61X09	Intel	S28	25 GbE	2
OCP 3.0	4TRD3	Mellanox	S28	25 GbE	2
OCP 3.0	TTKWY	SolarFlare	Q	25 GbE	2
OCP 3.0	8HRW3	SolarFlare	Q	25 GbE	2
OCP 3.0	RHVFN	Qlogic (Marvell)	SF+	10 GbE	2
OCP 3.0	NPOK8	Qlogic (Marvell)	S28	25 GbE	2
OCP 3.0	DN78C	Mellanox	S28	25 GbE	2

OCP NIC 3.0 and rack network daughter card comparison

Table 11. PowerEdge R650 OCP 3.0, 2.0, and rNDC NIC comparison

Form factor	Dell rNDC	OCP 2.0 (LOM Mezz)	OCP 3.0	Note
PCIe Gen	Gen 3	Gen 3	Gen 4	Supported OCP 3.0 are SFF (small form factor)
Max PCIe lanes	x8	Up to x16	Up to x16	See slot priority matrix
Shared LOM	Yes	Yes	Yes	This is iDRAC port redirect
Aux power	Yes	Yes	Yes	Used for shared LOM

SNAP I/O Support

SNAP Input Output value proposition

Dual-socket servers offer ample compute power to meet the needs of a wide range of workloads. However, if the network adapters in the system are unbalanced, users may be at risk of creating a bottleneck that will reduce bandwidth and increase latency. SNAP I/O is a solution which leverages Mellanox socket direct technology to balance I/O performance without increasing the TCO. By allowing both processors to share one adapter, data can avoid traversing the UPI inter-processor link when accessing remote memory

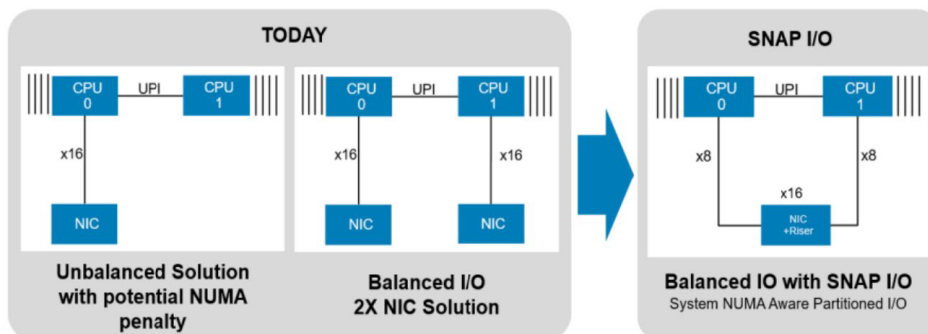

Figure 12. Comparing an unbalanced one-NIC solution and a balanced two-NIC solution to a SNAP I/O one-NIC solution

The SNAP I/O solution on the right allows CPU 0 and 1 to communicate to their corresponding NIC card without traversing the UPI channels, therefore reducing latency/TCO and freeing up UPI bandwidth for applications.

PCIe subsystem

Topics:

- PCIe risers

PCIe risers

The PowerEdge R650 have a no riser option. Shown below are the riser offerings for the PowerEdge R650.

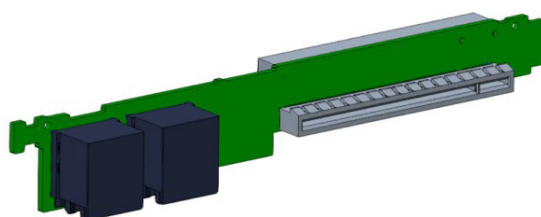

Figure 13. Riser 2A

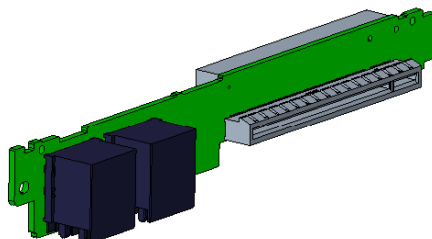

Figure 14. Riser 2B

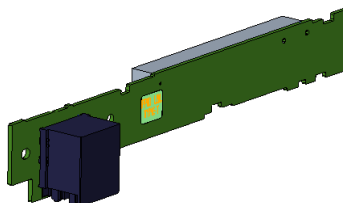

Figure 15. Riser 3A

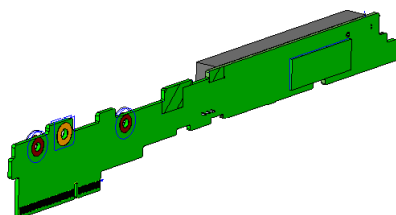

Figure 16. Riser R1A

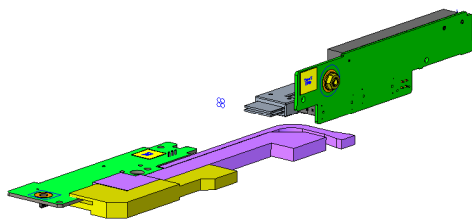

Figure 17. Riser 4C and 4D

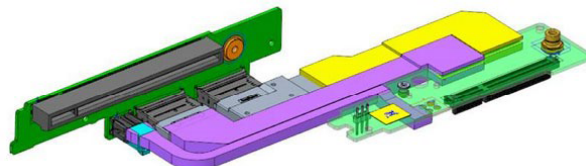

Figure 18. Riser 4

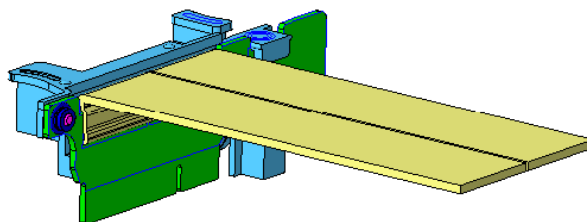

Figure 19. Riser R1D Paddle card (routes additional PCIe lanes for NVMe connection in the front backplane)

For details on SNAP I/O, see section [SNAP I/O support](#).

Table 12. Riser offerings

Config No.	Riser configuration	No. of CPUs	PERC type supported	Rear storage	x8 CPU1	x16 CPU1	x8 CPU2	x16 CPU2
0-1	R2a+R3a	1	fPERC	No	0	1	0	0
0-2	R2a+R3a	2	fPERC	No	0	1	0	2
1	R2b+R3a	2	fPERC	No	0	1	1	1
2	R3a	2	fPERC	Yes	0	0	0	1
3	R1a+R4c+R4d	2	fPERC	No	0	1	0	1
4	R2a+R3a+R1d paddlecard	2	No	No	0	1	0	2
5	R2b+R3a+R1d paddlecard	2	No	No	0	1	1	1
6	R3a+R1d paddlecard	2	No	Yes	0	0	0	1

Power, thermal, and acoustics

PowerEdge servers have an extensive collection of sensors that automatically track thermal activity, which helps regulate temperature thereby reducing server noise and power consumption. The table below lists the tools and technologies Dell offers to lower power consumption and increase energy efficiency.

Topics:

- [Power](#)
- [Thermal](#)
- [Acoustics](#)

Power

Table 13. Power Tools and Technologies

Feature	Description
Power Supply Units (PSU) portfolio	Dell's PSU portfolio includes intelligent features such as dynamically optimizing efficiency while maintaining availability and redundancy. Find additional information in the Power supply units section.
Industry Compliance	Dell's servers are compliant with all relevant industry certifications and guidelines, including 80 PLUS, Climate Savers, and ENERGY STAR.
Power monitoring accuracy	PSU power monitoring improvements include: <ul style="list-style-type: none"> • Dell's power monitoring accuracy is currently 1%, whereas the industry standard is 5% • More accurate reporting of power • Better performance under a power cap
Power capping	Use Dell's systems management to set the power cap limit for your systems to limit the output of a PSU and reduce system power consumption.
Systems Management	iDRAC Enterprise provides server- level management that monitors, reports, and controls power consumption at the processor, memory, and system level. Dell OpenManage Power Center delivers group power management at the rack, row, and data center level for servers, power distribution units, and uninterruptible power supplies.
Rack infrastructure	Dell offers some of the industry's highest- efficiency power infrastructure solutions, including: <ul style="list-style-type: none"> • Power distribution units (PDUs) • Uninterruptible power supplies (UPSs) • Energy Smart containment rack enclosures

Power Supply Units

Energy Smart power supplies have intelligent features, such as the ability to dynamically optimize efficiency while maintaining availability and redundancy. Also featured are enhanced power-consumption reduction technologies, such as high-efficiency

power conversion and advanced thermal-management techniques, and embedded power-management features, including high-accuracy power monitoring. The table below shows the power supply unit options that are available for the R650.

Table 14. Power Supply Unit Options

Wattage	Frequency	Voltage	Class	Heat dissipation
800W AC/ HVDC	50/60Hz	100~240Vac/9.2-4.7A	Platinum	3139 BTU/hr
	N/A	240Vdc/3.8A	N/A	3139 BTU/hr
1100W AC/ HVDC	50/60Hz	100~240Vac/12.65-6.3A	Titanium	4299 BTU/hr
	N/A	240Vdc/5.2A	N/A	4299 BTU/hr
1100W -48VDC	N/A	-48~-60Vdc/27A	N/A	4265 BTU/hr
1400W AC/ HVDC	50/60Hz	100~240Vac/12-8A	Platinum	5459 BTU/hr
	N/A	240Vdc/6.6A	N/A	5459 BTU/hr

i **NOTE:** If a system with AC 1400 W PSUs operates at low line 100-120 Vac, then the power rating per PSU is degraded to 1050W.

PSU rating

Below table lists the power capacity the PSUs in high/low line operation mode.

Table 15. PSUs highline and lowline ratings

—	800 W Platinum	1100 W Platinum	1400 W Platinum -48 V DC	1400 W Platinum
Peak power	1360 W	1870 W	1870 W	2380 W
Highline/-72 V DC	800 W	1100 W	1100 W	1400 W
Peak power	1360 W	1785 W	1870 W	1785 W
Lowline/-40 V DC	800 W	1050 W	1100 W	1050 W
Highline 240 V DC	800 W	1100 W	N/A	1400 W
Highline 200-380 V DC	N/A	N/A	N/A	N/A
DC-48-60 V	N/A	N/A	1100 W	N/A

The PowerEdge R650 supports up to 2 AC power supplies with 1+1 redundancy, autosensing, and auto switching capability.

If two PSUs are present during POST, a comparison is made between the wattage capacities of the PSUs. In the event that the PSU wattages do not match, the larger of the two PSUs is enabled. Also, there is a PSU mismatch warning displayed in BIOS, iDRAC, or on the system LCD.

If a second PSU is added at run-time, in order for that particular PSU to be enabled, the wattage capacity of the first PSU must equal the second PSU. Otherwise, the PSU will be flagged as unmatched in iDRAC and the second PSU will not be enabled.

Dell PSUs have achieved Platinum efficiency levels as shown in the table below.

Table 16. PSU efficiency level

Efficiency Targets by Load					
Output	Class	10%	20%	50%	100%
800 W AC	Platinum	89.00%	93.00%	94.00%	91.50%
1100 W AC	Titanium	90.00%	94.00%	96.00%	91.50%

Table 16. PSU efficiency level (continued)

Efficiency Targets by Load					
Output	Class	10%	20%	50%	100%
1100 W -48 V DC	N/A	85.00%	90.00%	92.00%	90.00%
1400 W AC	Platinum	89.00%	93.00%	94.00%	91.50%

Thermal

PowerEdge servers have an extensive collection of sensors that automatically track thermal activity, which helps regulate temperature thereby reducing server noise and power consumption.

Thermal design

Thermal management of the platform helps deliver high performance with the right amount of cooling to components, while maintaining the lowest fan speeds possible. This is done across a wide range of ambient temperatures from 10°C to 35°C (50°F to 95°F) and to extended ambient temperature ranges (see Thermal Restrictions).

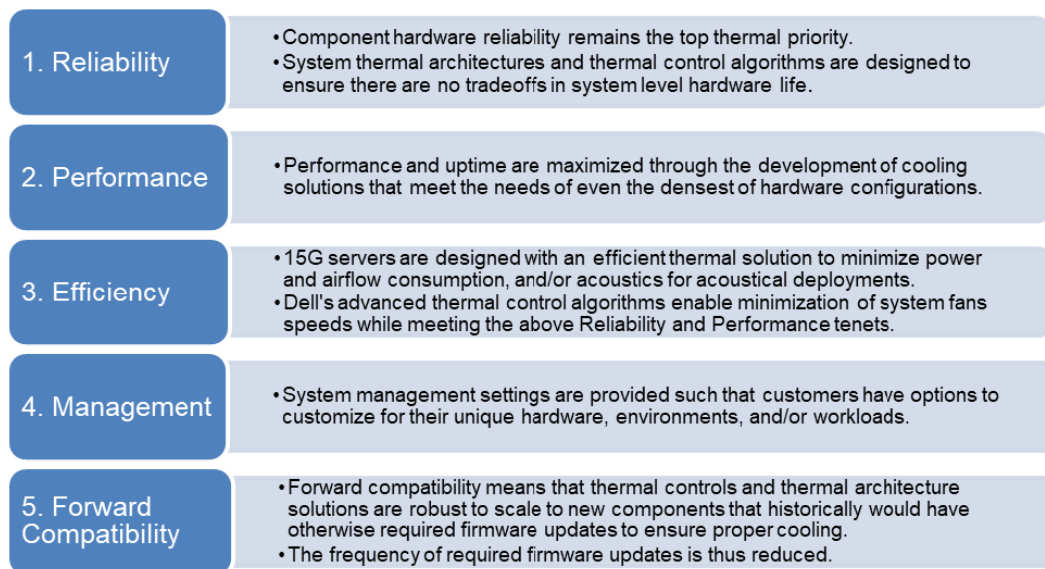

Figure 20. Thermal Design Characteristics

The thermal design of the PowerEdge R650 reflects the following:

- Optimized thermal design: The system layout is architected for optimum thermal design.
- System component placement and layout are designed to provide maximum airflow coverage to critical components with minimum expense of fan power.
- Comprehensive thermal management: The thermal control system regulates the fan speed based on several different responses from all system- component temperature sensors, as well as inventory for system configurations. Temperature monitoring includes components such as processors, DIMMs, chipset, the inlet air ambient, hard disk drives, OCP, and GPU.
- Open and closed loop thermal fan speed control: Open loop thermal control uses system configuration to determine fan speed based on inlet air ambient temperature. Closed loop thermal control method uses feedback temperatures to dynamically determine proper fan speeds.
- User-configurable settings: With the understanding and realization that every customer has unique set of circumstances or expectations from the system, in this generation of servers, we have introduced limited user- configurable settings residing in the iDRAC BIOS setup screen. For more information, see the Dell EMC PowerEdge R650 Installation and Service Manual at www.dell.com/poweredgemanuals and “Advanced Thermal Control: Optimizing across Environments and Power Goals” on Dell.com.
- Cooling redundancy: The R650 allows N+1 fan redundancy, allowing continuous operation with one fan failure in the system.

- Environmental Specifications: The optimized thermal management makes the R650 reliable under a wide range of operating environments.

Thermal restrictions

See Dell EMC PowerEdge R650 Technical Specifications on www.dell.com/poweredge/manuals for detailed thermal restrictions.

Thermal summary

Multi Vector cooling 2.0

Multi Vector Cooling (MVC) was introduced in 14G and has been improved upon here to increase cooling capability, customization and automation.

Design Innovation: Dell Multi Vector Cooling 2.0

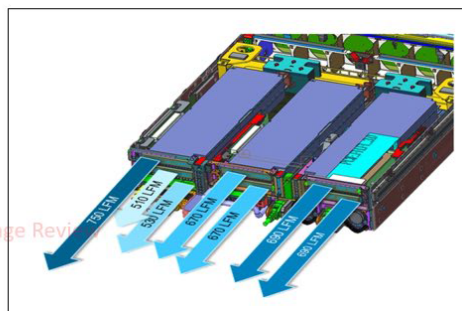
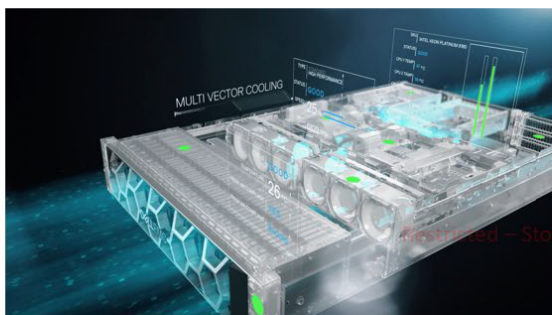

Advanced thermal design that **streamlines the airflow pathways** within the server, **directing the appropriate volume** of air to where it is needed inside the chassis

Minimize fan and system power consumption while **maintaining component reliability**. Providing **custom cooling options** without compromising baseline system **cooling needs**

Figure 21. Multi Vector Cooling Overview

Features included in this new iteration of MVC include:

- Patented Adaptive closed loop power capping
- Patented baseline fan speed algorithm
- Custom delta-t; allowing customers to specify outlet temperature (Requires iDRAC Datacenter)
- Custom PCIe inlet temp and airflow control among other custom cooling capabilities for PCIe devices (Requires iDRAC Datacenter)

Improved thermal design & cooling components

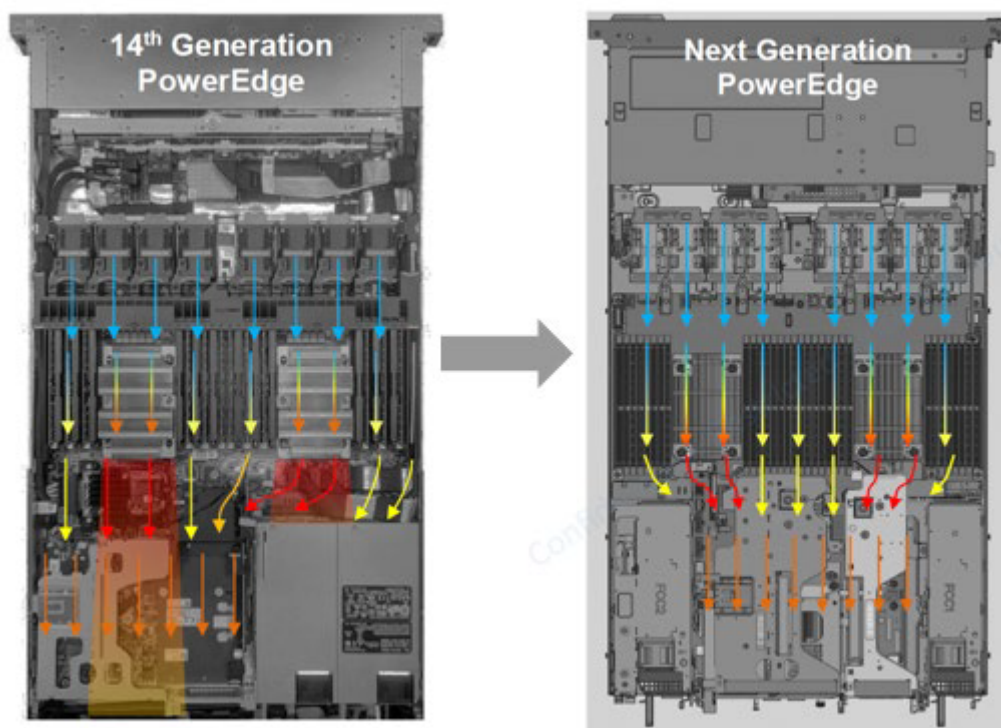

Figure 22. Balanced Airflow Chassis design

Balanced Airflow

- Split PSU design improves airflow through the system
- Enables optimized PCIe connectivity from CPU to rear PCIe slots

Smaller PSU form factor (except 2400W PSU)

- Allows additional “exhaust lanes” for hot airflow from CPUs

New “High-Performance Gold” Fans

- Provides enhanced performance required for cooling new high TDP CPUs

Acoustics

Acoustical design

Dell EMC PowerEdge delivers sound quality and smooth transient response in addition to sound power levels and sound pressure levels oriented to deployment environments.

Sound quality describes how disturbing or pleasing a person finds a sound, as a function of a variety of psycho-acoustical metrics and thresholds. Tone prominence is one such metric.

Transient response refers to how sound changes with time.

Sound power level, sound pressure level and loudness refer to amplitude of sound.

A reference for comparison to sound pressure levels and loudness for familiar noise sources is given in the table below.

Table 17. Acoustical Reference Points and Output Comparisons

Value measured at your ears		Equivalent familiar noise experience
LpA, dBA, re 20µPa	Loudness, sones	
90	80	Loud concert
75	40	Data center, vacuum cleaner, voice must be elevated to be heard
60	10	Conversation levels
45	4	Whispering, open office layout, normal living room
35	2	Quiet office
30	1	Quiet library
20	0	Recording studio

For more information about PowerEdge acoustical design and metrics, see [Understanding Acoustical Data and Causes of Sound in Dell Enterprise Products](#).

PowerEdge R650 acoustics

For more information on acoustical specifications, see ENG0019662. (See the category definitions.)

Dell typically categorizes servers in five categories of acoustically acceptable usage:

- Category 1: Table-top in Office Environment
- Category 2: Floor-standing in Office Environment
- Category 3: General Use Space
- Category 4: Attended Data Center
- Category 5: Unattended Data Center

Category 4: Attended Data Center

When Dell determines that a specific Enterprise product is to be predominantly used in an attended data center, then the acoustical specification of the table applies. The phrase “attended data center” is used to mean a space in which many (from tens to 1000s) of Enterprise products are deployed in proximity (that is, in the same room) to personnel whose speech (perhaps with raised voices) is expected to be intelligible over the data center noise. Hearing protection or hearing monitoring programs are not expected in these areas. Examples in this category include monolithic rack products. When Dell determines that a specific Enterprise product is to be predominantly used in a general use space, then the acoustical specification of the above table applies. These products could be found in laboratories, schools, restaurants, open office space layouts, small ventilated closets, etc., though not in close proximity to any particular person nor in quantities greater than a few in any location. People within proximity of a few of these products should not experience any impact to speech intelligibility or annoyance from the noise of the product. A rack product sitting on a table in a common area is an example.

Table 18. Dell Enterprise Category 4, “Attended Data Center” acoustical specification category.

Measurement Position re AC0158	Metric, re AC0159	Test Modes, re AC0159 (note must be in steady state, see AC0159, except where noted below)				Simulate (that is, set fan speeds representative) for 100% loading and maximum configuration, at 35° C Ambient
		Standby in 23±2° C Ambient	Idle in 23±2° C Ambient	Operating in 23±2° C Ambient – if not otherwise specified in the program’s configuration document, then processor and hard drive operating modes are required	Simulate (that is, set fan speeds representative) for Idle at 28° C & 35° C Ambient	
Sound Power	LWA,m, B	Report	≤ 6.9	≤ 7.1	Report	≤ 8.5

Table 18. Dell Enterprise Category 4, “Attended Data Center” acoustical specification category. (continued)

Measurement Position re AC0158	Metric, re AC0159	Test Modes, re AC0159 (note must be in steady state, see AC0159, except where noted below)				Simulate (that is, set fan speeds representative) for 100% loading and maximum configuration, at 35° C Ambient
		Standby in 23±2° C Ambient	Idle in 23±2° C Ambient	Operating in 23±2° C Ambient – if not otherwise specified in the program’s configuration document, then processor and hard drive operating modes are required	Simulate (that is, set fan speeds representative) for Idle at 28° C & 35° C Ambient	
Front Binaural HEAD	Tones, Hz, dB	Report	< 15 dB	< 15 dB	Report	< 20 dB
	Tonality, tu	Report	Report	Report	Report	Report
	Dell Modulation, %	Report	Report	Report	Report	Report
	Loudness, sones	Report	Report	Report	Report	Report
	LpA-single point, dBA	Report	Report	Report	Report	Report
	Transients	<ul style="list-style-type: none"> ● Oscillation (see AC0159), if observed, during 20-minute steady-state observation, must adhere to the following two criteria: <ul style="list-style-type: none"> ○ Max. {ΔLpA} < 3.0 dB ○ Event count < 3 for “1.5 dB < ΔLpA < 3.0 dB” ○ Acoustical Jump (see AC0159), during air mover speed transition from Idle to Operating Mode must be ≤ 15 dB. ○ Startup behavior <ul style="list-style-type: none"> ▪ Report Startup behavior re. AC0159 ▪ Startup must proceed smoothly, that is, no sudden or large jumps, and fan speed during startup must not exceed 50% of its maximum <p>∞ Transient inputs: Report time-history sound pressure levels re AC0159 “Train of Step Functions on Processor”</p>				N/A
Any	Other	<p>No rattles, squeaks, or unexpected noises</p> <p>Sound should be “even” around the EUT (one side should not be dramatically louder than another)</p> <p>Unless otherwise specified, the “default” thermal-related settings shall be selected for BIOS and iDRAC.</p> <p>Specific operating conditions will be defined in “Configurations & Configuration Dependencies” for each platform.</p>				
Sound Pressure	LpA-reported, dBA	Report for all mics	Report for all mics	Report for all mics	Report for all mics	Report for all mics

Acoustical performance

Dell EMC PowerEdge R650 is a rack-mount server appropriate for attended data center environment. However, lower acoustical output is attainable with proper hardware or software configurations.

Table 19. Lower Acoustical Output Configurations

Configuration	Minimum	Typical-1, 2.5 inches	Typical-2, 3.5 inches	GPU config
CPU Type	Intel Bottom Silver	Intel Low Gold 5	Intel Low Gold 5	Intel Top bin
CPU TDP	105W / 8C	150W / 16C	150W / 16C	270W / 32C
CPU Quantity	1	2	2	2
RDIMM Memory	8GB DDR4	32GB DDR4	16GB DDR4	64GB DDR4
Memory Quantity	8	16	8	32
Backplane Type	4x3.5 inches BP	10x2.5 inches BP	4x 3.5 inches BP + 2x 2.5 inches Rear BP	10x2.5 inches BP
HDD Type	3.5 inches 7.2K RPM SATA	6x 2.5 inche 10K RPM SAS 4x 2.5 inches 1TB NVMe	4x 3.5 inches 7.2K RPM SAS 2x 2.5 inches SAS SSD	2.5 inches 1TB NVMe
HDD Quantity	2	10	4+2	10
PSU Type	800 W	1400 W	800 W	1400 W
PSU Quantity	2	2	2	2
M.2	X	BOSS S2	X	BOSS S2
OCP	Dual Port 10GbE	Dual Port 25GbE	Dual Port 10GbE	Dual Port 25GbE
PCI 1	X	Dual Port 25GbE	X	Dual Port 200GbE
PCI 2	X	Dual Port 25GbE	X	X
Front PERC	PERC H345	PERC H745P	PERC H745P	PERC H745P
LOM Card	1 GB	1 GB	1 GB	1 GB
PERC	no	Yes	Yes	Yes

Table 20. Acoustical Performance for R650 acoustical configurations

Configuration	Minimum		Typical-1 (HPC)	Typical-2 (Rear storage)	Feature Rich
Acoustical Performance: Idle/ Operating @ 25 °C Ambient					
L wA,m (B)	Idle	5.0	6.4	6.0	6.4
	Operating	5.0	6.4	6.0	6.4
K v (B)	Idle	0.4	0.4	0.4	0.4
	Operating	0.4	0.4	0.4	0.4
L pA,m	Idle	35	47	42	47

Table 20. Acoustical Performance for R650 acoustical configurations (continued)

Configuration	Minimum		Typical-1 (HPC)	Typical-2 (Rear storage)	Feature Rich
(dB)	Operating	35	47	43	47
Prominent tones No prominent tones in Idle and Operating					
Acoustical Performance: Idle @ 28 °C Ambient					
L wA,m (B)		5.3	6.6	6.4	6.8
K v (B)		0.4	0.4	0.4	0.4
L pA,m (dB)		37	48	47	52
Acoustical Performance: Max. Loading @ 35 °C Ambient					
L wA,m (B)		6.8	7.9	7.6	7.9
K v (B)		0.4	0.4	0.4	0.4
L pA,m (dB)		51	60	62	63

NOTE:

- LwA,m: The declared mean A-weighted sound power level (LwA) is calculated per section 5.2 of ISO 9296 (2017) with data collected using the methods described in ISO 7779 (2010). Data presented here may not be fully compliant with ISO 7779.
- LpA,m: The declared mean A-weighted emission sound pressure level is at the bystander position per section 5.3 of ISO 9296 (2017) and measured using methods described in ISO 7779 (2010). The system is placed in a 24U rack enclosure, 25cm above a reflective floor. Data presented here may not be fully compliant with ISO 7779.
- Prominent tones: Criteria of D.6 and D.11 of ECMA-74 (17 th ed., Dec. 2019) are followed to determine if discrete tones are prominent and to report them, if so.
- Idle mode: The steady-state condition in which the server is energized but not operating any intended function.
- Operating mode: The maximum of the steady state acoustical output at 50% of CPU TDP or active HDDs per C.9.3.2 in ECMA-74 (17 th ed., Dec. 2019).

PowerEdge R650 acoustical dependencies

Some product features impact acoustical server output more than others. The following features are considered strong drivers of acoustical response, thus configurations or operating conditions that include these features may increase air mover speed and acoustical output of the server:

- Ambient temperature: Dell EMC evaluates the acoustical performance of servers in a 23±2°C environment. Ambient temperatures in excess of 25°C will have higher acoustical output and may experience larger fluctuations between state changes.
- CPU thermal design power (TDP): higher wattage CPUs may require more airflow to cool under load and thus increase the potential acoustical output of the system.
- Storage type: NVME SSD consumes more power than SAS/SATA drive technologies and therefore demands more airflow to achieve system cooling targets.
- System thermal profile selection in BIOS or iDRAC GUI:
 - Default Thermal Profile generally provides a lower air mover speed thus lower acoustical output than those of other thermal profiles.
 - Maximum Performance (Performance Optimized) will result in higher acoustical output.
 - Sound Cap, for products that support the feature, will limit the maximum acoustical output of the system by sacrificing some processor performance.
- Rear drives: when drives are installed into the rear drive cage of the R650, the idle and operating acoustical outputs may be higher.
- GPU/FPGA/Acceleration Cards: when installed, system acoustical output may be significantly higher than configurations without acceleration cards.

- GPU, FPGA, or other accelerator cards often push the limits of power and cooling requirements in the PCI form factor. To accommodate the increased power, system configurations that include accelerator cards may be significantly louder, due to higher fan speeds, than systems without these specialized adapters. The increased acoustical output of these systems may be particularly noticeable during system bootup where fan speeds may reach 100% of fan speed capability to guarantee cards remain within their thermal limits while thermal telemetry is established on bootup.
- BOSS S2 module: If any BOSS S2 module is installed and “Maximum Performance (Performance Optimized)” is selected, fan speed and acoustical noise may significantly increase at IDLE condition.

Methods to reduce acoustical output of the R650

Although the R650 is designed for use in data centers, some users may prefer to use it in a quieter setting. The following is a list of means to do so. Please note however in most cases, the idle air mover speed of the system cannot be lowered without changing the configuration of the system, and in some cases, even a configuration change may not reduce idle air mover speeds.

- Enable sound cap in iDRAC GUI: Sound cap, a setting in the BIOS, can be toggled on/off during boot up. When enabled, sound cap reduces the acoustics of the system at the expense of some performance.
- Reduce ambient temperature: Lowering the ambient temperature allows the system to cool components more efficiently than at higher ambient temperatures.
- Set target in Third party PCIe card options: Dell EMC provides airflow customization for third-party PCIe adapters installed in PowerEdge platforms. If automatic cooling response is above desired levels (LFM) based on the card specifications, a different LFM target can be set using PCIe Airflow Settings options in iDRAC GUI.
- Replace third party PCI cards with similar Dell supported temperature-controlled cards, if available. Dell EMC works diligently with card vendors to validate and develop PCI cards to meet Dell EMC's exacting standards for thermal performance.

Rack information

The PowerEdge R650 offers two different varieties of sliding rails: Drop-in sliding rails, and combination Stab-in/Drop-in sliding rails. Only one variety of static rail is offered: Stab-in.

A Drop-in design means that the system is installed vertically into the rails by inserting the standoffs on the sides of the system into the J-slots in the inner rail members with the rails in the fully extended position. The recommended method of installation is to first insert the rear standoffs on the system into the rear J-slots on the rails in order to free up a hand and then rotate the system down into the remaining J-slots while using the free hand to hold the rail against the side of the system.

A Stab-in design means that the inner (chassis) rail members must first be attached to the sides of the system and then inserted into the outer (cabinet) members installed in the rack. For 2U systems, this is a 2- person lift.

Topics:

- [Static rails](#)
- [Sliding rails](#)

Static rails

The static rails (shown in the figure below) support a wider variety of racks than the sliding rails, but do not support serviceability in the rack. The static rails are not compatible with the CMA and SRB.

A14 ReadyRails static rails for 4-post and 2-post racks:

- Supports Stab-in installation of the chassis to the rails.
- Support tool-less installation in 19" EIA-310-E compliant square or unthreaded round hole 4-post racks including all generations of Dell racks.
- Support tooled installation in 19" EIA-310-E compliant threaded hole 4-post and 2-post racks.
- Support for tooled installation in Dell EMC Titan or Titan-D rack.

i NOTE:

- Screws are not included with the static rail kit since racks are offered with various thread types. The screws are provided for mounting static rails in racks with threaded mounting flanges.
- Screw head diameter should be 10 mm or less.

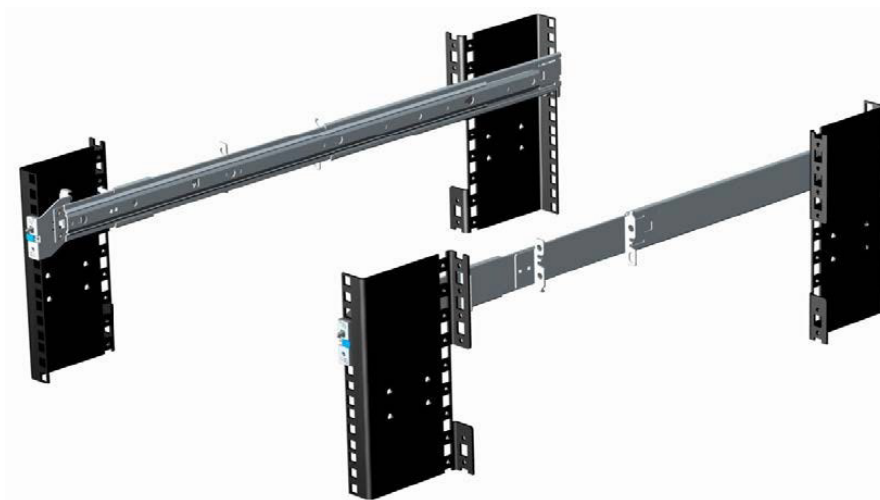

Figure 23. Static Rails

Sliding rails

The sliding rails (shown in the figure below) allow the system to be fully extended out of the rack for service. The sliding rails have a CMA and a SRB option. There are two types of sliding rails available in 15G, ReadyRails II sliding rails and Stab-in/Drop-in sliding rails.

A15 ReadyRails II sliding rails for 4-post racks:

- Supports Drop-in installation of the chassis to the rails.
- Support for tool-less installation in 19" EIA-310-E compliant square or unthreaded round hole 4-post racks including all generations of Dell racks.
- Support for tooled installation in 19" EIA-310-E compliant threaded hole 4-post racks.
- Support full extension of the system out of the rack to allow serviceability of key internal components.
- Support for optional cable management arm (CMA).
- Support for optional strain relief bar (SRB) static rails.

i NOTE: For situations where CMA support is not required, the outer CMA mounting brackets can be uninstalled from the sliding rails. This reduces the overall length of the rails and eliminates the potential interferences with rear mounted PDUs or the rear rack door.

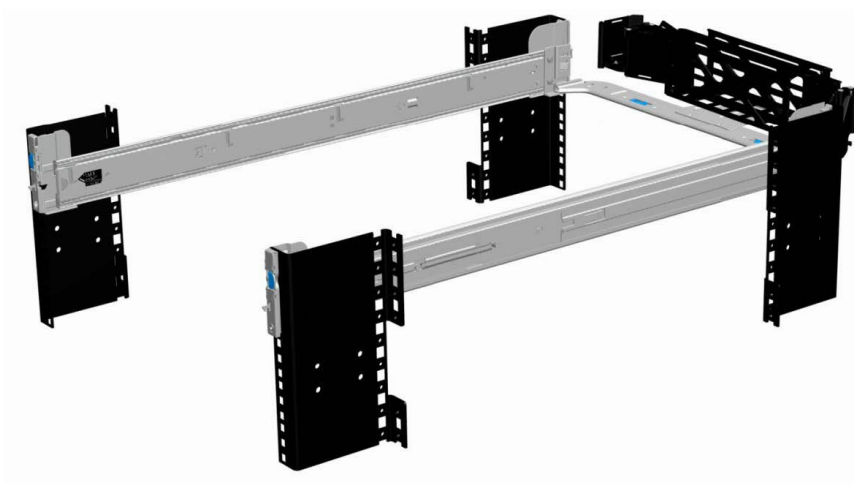

Figure 24. Sliding Rails with Optional CMA



Figure 25. Sliding Rails with optional SRB

A16 Stab-in/Drop-in sliding rails for 4-post racks

- Supports Drop-in or Stab-in installation of the chassis to the rails.
- Support for tool-less installation in 19" EIA-310-E compliant square, unthreaded round hole racks including all generations of Dell racks. Also supports tool-less installation in threaded round hole 4-post racks.
- Support full extension of the system out of the rack to allow serviceability of key internal components.
- Support for optional cable management arm (CMA).
- Support for optional strain relief bar (SRB).

i NOTE: For situations where CMA support is not required, the outer CMA mounting brackets can be uninstalled from the sliding rails. This reduces the overall length of the rails and eliminates the potential interferences with rear mounted PDUs or the rear rack door.

Scan the QRL code for the documentation and trouble-shooting information regarding the installation procedures for Drop-in/Stab in rail types.

Supported operating systems

The following lists the supported operating systems for the PowerEdge R650:

- RedHat Enterprise Linux 7.9 Server x86_64
- RedHat Enterprise Linux 8.2 Server x86_64
- RedHat Enterprise Linux 8.3 Server x86_64
- Novell SuSE Linux Enterprise Server 15 SP2 x86_64
- MS, Windows Server 2016
- MS, Windows Server 2019
- Ubuntu 20.04
- VMWare vSphere 6.7 U3 (ESXi 6.7 U3)
- VMWare vSphere 7.0 U1 (ESXi 7.0 U1)
- VMWare vSphere 7.0 U2 (ESXi 7.0 U2)
- VMWare vSphere 2019 (ESXi 2019)
- Citrix Xen Server 8.2 LTSR

The link to the specific OS versions and editions, certification matrices, hardware compatibility lists (HCL) portal, and hypervisor support can be found at [Dell EMC Enterprise Operating Systems](#).

Dell EMC OpenManage systems management

Dell EMC OpenManage Portfolio

Simplifying hardware management through ease of use and automation

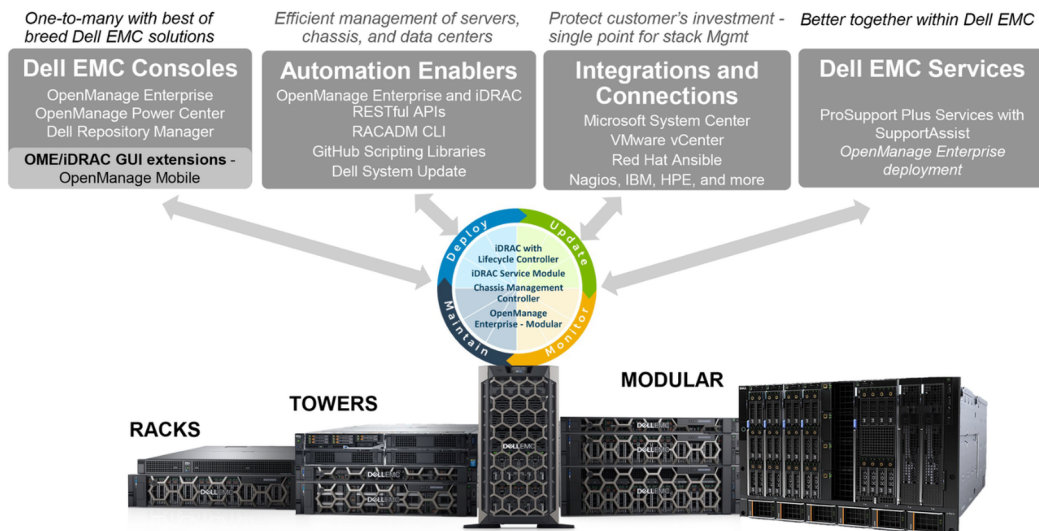

Figure 26. Dell EMC OpenManage Portfolio

Dell EMC delivers management solutions that help IT Administrators effectively deploy, update, monitor, and manage IT assets. OpenManage solutions and tools enable you to quickly respond to problems by helping them to manage Dell EMC servers effectively and efficiently; in physical, virtual, local, and remote environments, operating in-band, and out-of-band (agent-free). The OpenManage portfolio includes innovative embedded management tools such as the integrated Dell Remote Access Controller (iDRAC), Chassis Management Controller and Consoles like OpenManage Enterprise, OpenManage Power Manager plug in, and tools like Repository Manager.

Dell EMC has developed comprehensive systems management solutions based on open standards and has integrated with management consoles that can perform advanced management of Dell hardware. Dell EMC has connected or integrated the advanced management capabilities of Dell hardware into offerings from the industry's top systems management vendors and frameworks such as Ansible, thus making Dell EMC platforms easy to deploy, update, monitor, and manage.

The key tools for managing Dell EMC PowerEdge servers are iDRAC and the one-to-many OpenManage Enterprise console. OpenManage Enterprise helps the system administrators in complete lifecycle management of multiple generations of PowerEdge servers. Other tools such as Repository Manager, which enables simple yet comprehensive change management.

OpenManage tools integrate with systems management framework from other vendors such as VMware, Microsoft, Ansible, and ServiceNow. This enables you to use the skills of the IT staff to efficiently manage Dell EMC PowerEdge servers.

Topics:

- [Server and Chassis Managers](#)
- [Dell EMC consoles](#)
- [Automation Enablers](#)
- [Integration with third-party consoles](#)
- [Connections for third-party consoles](#)
- [Dell EMC Update Utilities](#)
- [Dell resources](#)

Server and Chassis Managers

- Integrated Dell Remote Access Controller (iDRAC)
- iDRAC Service Module (iSM)

Dell EMC consoles

- Dell EMC OpenManage Enterprise
- Dell EMC Repository Manager (DRM)
- Dell EMC OpenManage Enterprise Power Manager plugin to OpenManage Enterprise
- Dell EMC OpenManage Mobile (OMM)

Automation Enablers

- OpenManage Ansible Modules
- iDRAC RESTful APIs (Redfish)
- Standards-based APIs (Python, PowerShell)
- RACADM Command Line Interface (CLI)
- GitHub Scripting Libraries

Integration with third-party consoles

- Dell EMC OpenManage Integrations with Microsoft System Center
- Dell EMC OpenManage Integration for VMware vCenter (OMIVV)
- Dell EMC OpenManage Ansible Modules
- Dell EMC OpenManage Integration with ServiceNow

Connections for third-party consoles

- Micro Focus and other HPE tools
- OpenManage Connection for IBM Tivoli
- OpenManage Plug-in for Nagios Core and XI

Dell EMC Update Utilities

- Dell System Update (DSU)
- Dell EMC Repository Manager (DRM)
- Dell EMC Update Packages (DUP)
- Dell EMC Server Update Utility (SUU)
- Dell EMC Platform Specific Bootable ISO (PSBI)

Dell resources

For additional information about white papers, videos, blogs, forums, technical material, tools, usage examples, and other information, go to the OpenManage page at <https://www.dell.com/openmanagemanuals> or the following product pages:

Table 21. Dell resources

Resource	Location
Integrated Dell Remote Access Controller (iDRAC)	https://www.dell.com/idracmanuals
iDRAC Service Module (iSM)	https://www.dell.com/support/kbdoc/000178050/
OpenManage Ansible Modules	https://www.dell.com/support/kbdoc/000177308/
OpenManage Essentials (OME)	https://www.dell.com/support/kbdoc/000175879/
OpenManage Mobile (OMM)	https://www.dell.com/support/kbdoc/000176046
OpenManage Integration for VMware vCenter (OMIVV)	https://www.dell.com/support/kbdoc/000176981/
OpenManage Integration for Microsoft System Center (OMIMSSC)	https://www.dell.com/support/kbdoc/000147399
Dell EMC Repository Manager (DRM)	https://www.dell.com/support/kbdoc/000177083
Dell EMC System Update (DSU)	https://www.dell.com/support/kbdoc/000130590
Dell EMC Platform Specific Bootable ISO (PSBI)	Dell.com/support/article/sln296511
Dell EMC Chassis Management Controller (CMC)	www.dell.com/support/article/sln311283
OpenManage Connections for Partner Consoles	https://www.dell.com/support/kbdoc/000146912
OpenManage Enterprise Power Manager	https://www.dell.com/support/kbdoc/000176254
OpenManage Integration with ServiceNow (OMISNOW)	Dell.com/support/article/sln317784

 **NOTE:** Features may vary by server. Please refer to the product page on <https://www.dell.com/manuals> for details.

Dell Technologies Services

Dell Technologies Services include a wide, customizable range of service choices to simplify the assessment, design, implementation, management and maintenance of IT environments and to help you transition from platform to platform. Depending on your current business requirements and the level of service right for you, we provide factory, on-site, remote, modular, and specialized services that fit your needs and budget. We'll help with a little or a lot—your choice—and provide access to our global resources.

For more information, see DellEMC.com/Services.

Topics:

- [Dell EMC ProDeploy Enterprise Suite](#)
- [Dell EMC Remote Consulting Services](#)
- [Dell EMC Data Migration Service](#)
- [Dell EMC ProSupport Enterprise Suite](#)
- [Dell EMC ProSupport Plus for Enterprise](#)
- [Dell EMC ProSupport for Enterprise](#)
- [Dell EMC ProSupport One for Data Center](#)
- [ProSupport for HPC](#)
- [Support Technologies](#)
- [Dell Technologies Education Services](#)
- [Dell Technologies Consulting Services](#)
- [Dell EMC Managed Services](#)

Dell EMC ProDeploy Enterprise Suite

ProDeploy Enterprise Suite gets your server out of the box and into optimized production—fast. Our elite deployment engineers with broad and deep experience utilizing best-in-class processes along with our established global scale can help you around the clock and around the globe. From simple to the most complex server installations and software integration, we take the guess work and risk out of deploying your new server technology.

		Basic Deployment	ProDeploy	ProDeploy Plus
Pre-deployment	Single point of contact for project management	-	●	In-region
	Site readiness review	-	●	●
	Implementation planning	-	●	●
	SAM engagement for ProSupport Plus entitled devices	-	-	●
Deployment	Deployment service hours	Business hours	24x7	24x7
	Remote guidance for hardware installation or Onsite hardware installation and packaging material removal	Onsite	Remote or Onsite	Onsite
	Install and configure system software	-	Remote	Onsite
	Install support software and connect with Dell Technologies	-	●	●
	Project documentation with knowledge transfer	-	●	●
Post-deployment	Deployment verification	-	●	●
	Configuration data transfer to Dell EMC technical support	-	●	●
	30-days of post-deployment configuration assistance	-	-	●
	Training credits for Dell EMC Education Services	-	-	●

Figure 27. ProDeploy Enterprise Suite capabilities

NOTE: Hardware installation not applicable on selected software products.

Dell EMC ProDeploy Plus

From beginning to end, ProDeploy Plus provides the skill and scale needed to successfully execute demanding deployments in today's complex IT environments. Certified Dell EMC experts start with extensive environmental assessments and detailed migration planning and recommendations. Software installation includes set up of most versions of Dell EMC SupportAssist and OpenManage system management utilities. Post-deployment configuration assistance, testing, and product orientation services are also available.

Dell EMC ProDeploy

ProDeploy provides full service installation and configuration of both server hardware and system software by certified deployment engineers including set up of leading operating systems and hypervisors as well as most versions of Dell EMC SupportAssist and OpenManage system management utilities. To prepare for the deployment, we conduct a site readiness review and implementation planning exercise. System testing, validation, and full project documentation with knowledge transfer complete the process.

Basic Deployment

Basic Deployment delivers worry-free professional installation by experienced technicians who know Dell EMC servers inside and out.

Dell EMC Server Configuration Services

With Dell EMC Rack Integration and other Dell EMC PowerEdge Server Configuration Services, you save time by receiving your systems racked, cabled, tested, and ready to integrate into the data center. Dell EMC staff pre-configure RAID, BIOS and iDRAC settings, install system images, and even install third-party hardware and software.

For more information, see [Server Configuration Services](#).

Dell EMC Residency Services

Residency Services helps customers transition to new capabilities quickly with the assistance of on-site or remote Dell EMC experts whose priorities and time you control. Residency experts can provide post implementation management and knowledge transfer related to a new technology acquisition or day-to-day operational management of the IT infrastructure.

Dell EMC Remote Consulting Services

When you are in the final stages of your PowerEdge server implementation, you can rely on Dell EMC Remote Consulting Services and our certified technical experts to help you optimize your configuration with best practices for your software, virtualization, server, storage, networking, and systems management.

Dell EMC Data Migration Service

Protect your business and data with our single point of contact to manage your data migration project. Your project manager will work with our experienced team of experts to create a plan using industry-leading tools and proven processes based on global best practices to migrate your existing files and data so your business system get up and running quickly and smoothly.

Dell EMC ProSupport Enterprise Suite

With the ProSupport Enterprise Suite, we help keep your IT systems running smoothly, so you can focus on running your business. We will help maintain peak performance and availability of your most essential workloads. ProSupport Enterprise Suite is a suite of support services that enable you to build the solution that is right for your organization.

Choose support models based on how you use technology and where you want to allocate resources. From the desktop to the data center, address everyday IT challenges, such as unplanned downtime, mission-critical needs, data and asset protection, support planning, resource allocation, software application management and more. Optimize IT resources by choosing the right support model.



Figure 28. Dell EMC ProSupport Enterprise Suite

Dell EMC ProSupport Plus for Enterprise

When you purchase your PowerEdge server, we recommend ProSupport Plus, our proactive and preventative support service for your business-critical systems. ProSupport Plus provides you with all the benefits of ProSupport, plus the following:

- An assigned Services Account Manager who knows your business and your environment
- Immediate advanced troubleshooting from an engineer who understands your PowerEdge server
- Personalized, preventive recommendations based on analysis of support trends and best practices from across the Dell Technologies infrastructure solutions customer base to reduce support issues and improve performance
- Predictive analysis for issue prevention and optimization enabled by SupportAssist
- Proactive monitoring, issue detection, notification, and automated case creation for accelerated issue resolution enabled by SupportAssist
- On-demand reporting and analytics-based recommendations enabled by SupportAssist and TechDirect

Dell EMC ProSupport for Enterprise

Our ProSupport service offers highly trained experts around the clock and around the globe to address your IT needs. We help minimize disruptions and maximize availability of PowerEdge server workloads with:

- 24x7 support through phone, chat and online
- Predictive, automated tools and innovative technology
- A central point of accountability for all hardware and software issues
- Collaborative 3rd party support
- Hypervisor, operating system and application support
- Consistent experience regardless of where you are located or what language you speak
- Optional onsite parts and labor response options including next business day or four-hour mission critical

i **NOTE:** Subject to service offer country availability.

Enterprise Support Services Feature Comparison

	Basic	ProSupport	ProSupport Plus
Remote technical support	9x5	24x7	24x7
Covered products	Hardware	Hardware Software	Hardware Software
Onsite hardware support	Next business day	Next business day or 4hr mission critical	Next business day or 4 hr mission critical
3 rd party collaborative assistance		●	●
Automated issue detection & proactive case creation		●	●
Self-service case initiation and management		●	●
Access to software updates		●	●
Priority access to specialized support experts			●
3 rd party software support			●
Assigned Services Account Manager			●
Personalized assessments and recommendations			●
Semiannual systems maintenance			●

Availability and terms of Dell Technologies services vary by region and by product. For more information, please view our Service Descriptions available on Dell.com

Figure 29. Dell EMC Enterprise Support model

Dell EMC ProSupport One for Data Center

ProSupport One for Data Center offers flexible site-wide support for large and distributed data centers with more than 1,000 assets. This offering is built on standard ProSupport components that leverage our global scale but are tailored to your company's needs. While not for everyone, this service option offers a truly unique solution for Dell Technologies largest customers with the most complex environments.

- Team of assigned Services Account Managers with remote, on-site options
- Assigned ProSupport One technical and field engineers who are trained on your environment and configurations
- On-demand reporting and analytics-based recommendations enabled by SupportAssist and TechDirect
- Flexible on-site support and parts options that fit your operational model
- A tailored support plan and training for your operations staff

ProSupport for HPC

The ProSupport for HPC provides solution-aware support including:

- Access to senior HPC experts
- Advanced HPC cluster assistance: performance, interoperability & configuration
- Enhanced HPC solution level end-to-end support
- Remote pre-support engagement with HPC Specialists during ProDeploy implementation

Learn more at DellEMC.com/HPC-Services.

ProSupport Add-on for HPC

Delivering a true end-to-end support experience across your HPC environment

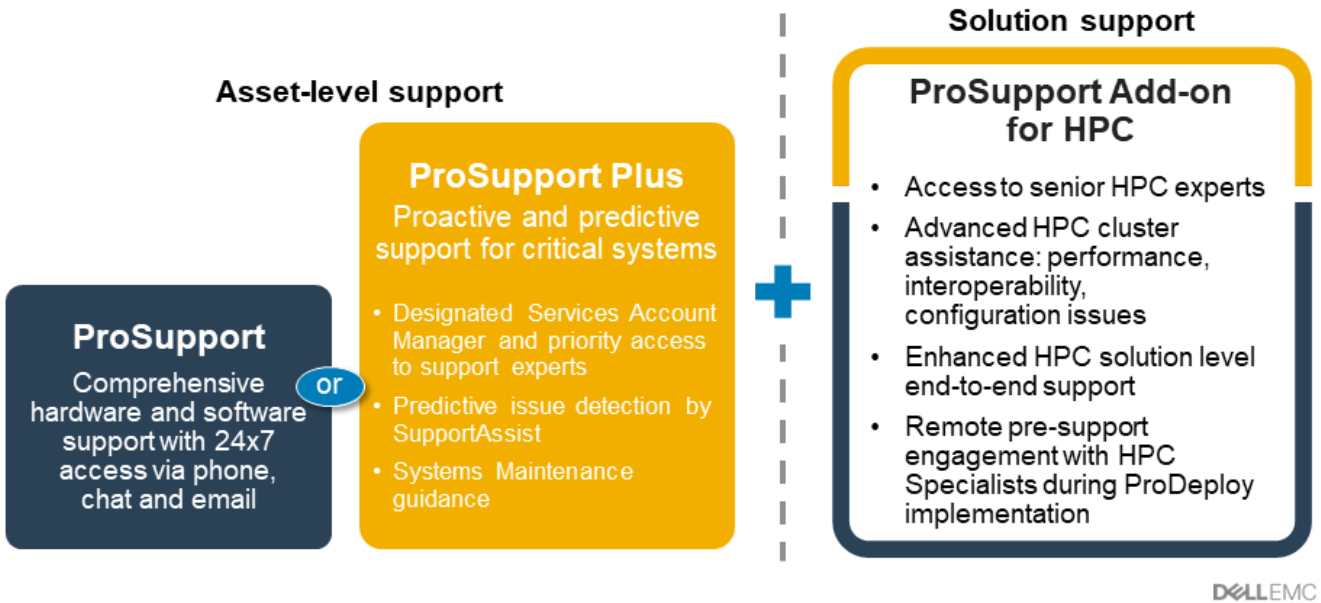

Figure 30. ProSupport for HPC

Support Technologies

Powering your support experience with predictive, data-driven technologies.

Dell EMC SupportAssist

The best time to solve a problem is before it happens. The automated proactive and predictive technology SupportAssist helps reduce steps and time to resolution, often detecting issues before they become a crisis. Benefits include:

- Value—SupportAssist is available to all customers at no additional charge
- Improve productivity—replace manual, high-effort routines with automated support
- Accelerate time to resolution—receive issue alerts, automatic case creation, and proactive contact from Dell EMC experts
- Gain insight and control—optimize enterprise devices with on-demand ProSupport Plus reporting in TechDirect, and get predictive issue detection before the problem starts

NOTE: SupportAssist is included with all support plans, but features vary based on service level agreement.

	Basic Hardware Warranty	ProSupport	ProSupport Plus
Automated issue detection and system state information collection	•	•	•
Proactive, automated case creation and notification		•	•
Predictive issue detection for failure prevention			•
Recommendation reporting available on-demand in TechDirect			•

Figure 31. SupportAssist model

Get started at Dell.com/SupportAssist

Dell EMC TechDirect

Boost IT team productivity when supporting Dell EMC systems. With over 1.4 million self-dispatches processed each year, TechDirect has proven its effectiveness as a support tool. You can:

- Self-dispatch replacement parts
- Request technical support
- Integrate APIs into your help desk

Or, access all your Dell EMC certification and authorization requirements. Train your staff on Dell EMC products, as TechDirect allows you to:

- Download study guides
- Schedule certification and authorization exams
- View transcripts of completed courses and exams

Register at techdirect.dell.

Dell Technologies Education Services

Build the IT skills required to influence the transformational outcomes of the business. Enable talent and empower teams with the right skills to lead and execute transformational strategy that drives competitive advantage. Leverage the training and certification required for real transformation.

Dell Technologies Education Services offers PowerEdge server training and certifications designed to help you achieve more from your hardware investment. The curriculum delivers the information and the practical, hands-on skills that you and your team need to confidently install, configure, manage, and troubleshoot your Dell EMC servers. To learn more or register for a class today, see LearnDell.com/Server.

Dell Technologies Consulting Services

Our expert consultants help you transform faster, and quickly achieve business outcomes for the high value workloads Dell EMC PowerEdge systems can handle.

From strategy to full-scale implementation, Dell Technologies Consulting can help you determine how to execute your IT, workforce, or application transformation.

We use prescriptive approaches and proven methodologies combined with Dell Technologies' portfolio and partner ecosystem to help you achieve real business outcomes. From multi-cloud, applications, DevOps, and infrastructure transformations, to business resiliency, data center modernization, analytics, workforce collaboration, and user experiences—we're here to help.

Dell EMC Managed Services

Reduce the cost, complexity, and risk of managing IT. Focus your resources on digital innovation and transformation while our experts help optimize your IT operations and investment with managed services backed by guaranteed service levels.

Appendix A. Additional specifications

Topics:

- Chassis dimension
- Chassis weight
- Video specifications
- USB Ports
- PSU rating
- Environmental Specifications

Chassis dimension

The PowerEdge R650 has the following dimensions:

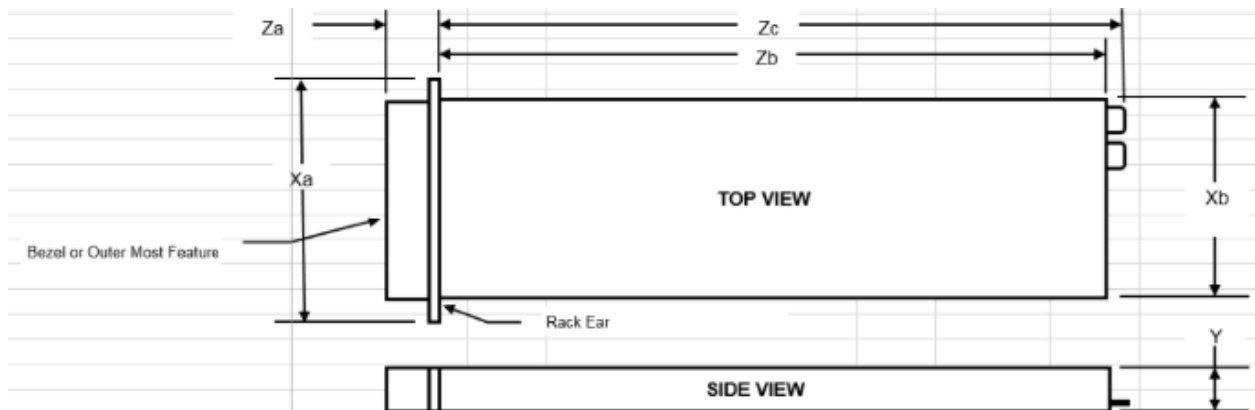

Figure 32. Chassis dimensions

Table 22. Chassis dimensions

Model number	Xa	Xb	Y	Za with bezel	Za without bezel	Zb	Zc	Max Sys Wgt	Chassis (U)
R650 (8 drives)	482 mm	434 mm	42.8 mm	35.84 mm	22 mm	700.7 mm	736.27 mm	19.2 kg	1U
R650 (4/10 drives)	482 mm	434 mm	42.8 mm	35.84 mm	22 mm	751.48 mm	787.05 mm	21.2 kg	1U

Chassis weight

Table 23. Chassis Weight

System	Maximum Weight
4 x 3.5-inch chassis	21.2 kg
10 x 2.5-inch chassis	21.0 kg

Table 23. Chassis Weight (continued)

System	Maximum Weight
8 x 2.5-inch chassis	19.2 kg

Video specifications

The PowerEdge R650 supports the following video resolution and refresh rates:

Table 24. Video specifications for PowerEdge R650

Resolution	Refresh Rate	Freq.	Pixel Clock	DVO DisplayPort
1024 x 768	60 Hz	48.4 kHz	65.0 MHz	Yes*
1280 x 800	60 Hz	49.7 kHz	83.5 MHz	Yes*
1280 x 1024	60 Hz	64.0 kHz	108.0 MHz	Yes*
1360 x 768	60 Hz	47.71 kHz	85.5 MHz	Yes*
1440 x 900	60 Hz	55.9 kHz	106.5 MHz	Yes*
1600 x 900	60 Hz	55.54 kHz	97.75 MHz	Yes*
1600 x 1200	60 Hz	75.0 kHz	162.0 MHz	Yes*
1680 x 1050	60 Hz	64.7 kHz	119.0 MHz	Yes*
1920 x 1080	60 Hz (RB)	67.158 kHz	173.0 MHz	No
1920 x 1200	60 Hz (RB)	74.556 kHz	193.25 MHz	No

*DVO - DP is for investigation only, dependent on Nuvoton DVO capabilities to support up to 165MHz.

*(RB) - Reduced Blanking for Digital Displays requiring less blank time. This was introduced for Signal Integrity improvements by reducing Pixel Clock rates for VGA- Analog input devices.

USB Ports

All USB ports follow USB specifications. Front USB 2.0 port only supports output current up to 0.5 A and do not support high power consumption devices such as CD-ROM. The bottom port of the rear USB connector can support USB 3.0 to supply output current up to 0.9 A.

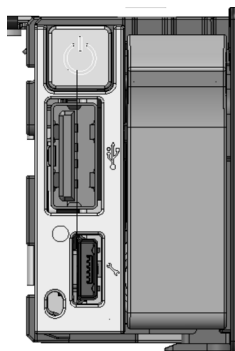

Figure 33. USB 2.0 port

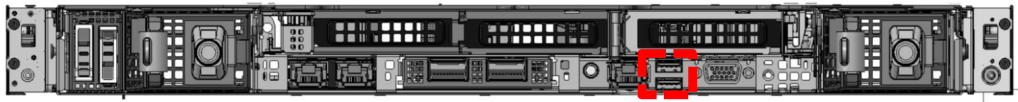

Figure 34. Rear USB 3.0 port (bottom) and USB 2.0 port (top)

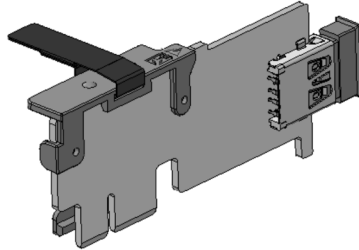

Figure 35. Internal USB 3.0 card, size is 40 x 16 x 8 mm (L x W x H)

PSU rating

Below table lists the power capacity the PSUs in high/low line operation mode.

Table 25. PSUs highline and lowline ratings

—	800 W Platinum	1100 W Platinum	1400 W Platinum -48 V DC	1400 W Platinum
Peak power	1360 W	1870 W	1870 W	2380 W
Highline/-72 V DC	800 W	1100 W	1100 W	1400 W
Peak power	1360 W	1785 W	1870 W	1785 W
Lowline/-40 V DC	800 W	1050 W	1100 W	1050 W
Highline 240 V DC	800 W	1100 W	N/A	1400 W
Highline 200-380 V DC	N/A	N/A	N/A	N/A
DC-48-60 V	N/A	N/A	1100 W	N/A

The PowerEdge R650 supports up to 2 AC power supplies with 1+1 redundancy, autosensing, and auto switching capability.

If two PSUs are present during POST, a comparison is made between the wattage capacities of the PSUs. In the event that the PSU wattages do not match, the larger of the two PSUs is enabled. Also, there is a PSU mismatch warning displayed in BIOS, iDRAC, or on the system LCD.

If a second PSU is added at run-time, in order for that particular PSU to be enabled, the wattage capacity of the first PSU must equal the second PSU. Otherwise, the PSU will be flagged as unmatched in iDRAC and the second PSU will not be enabled.

Dell PSUs have achieved Platinum efficiency levels as shown in the table below.

Table 26. PSU efficiency level

Efficiency Targets by Load					
Output	Class	10%	20%	50%	100%
800 W AC	Platinum	89.00%	93.00%	94.00%	91.50%
1100 W AC	Titanium	90.00%	94.00%	96.00%	91.50%
1100 W -48 V DC	N/A	85.00%	90.00%	92.00%	90.00%
1400 W AC	Platinum	89.00%	93.00%	94.00%	91.50%

Environmental Specifications

See the *PowerEdge R650 Technical Specifications* on www.dell.com/poweredgemanuals for detailed environmental specifications.

Thermal restrictions

See *Dell EMC PowerEdge R650 Technical Specifications* on www.dell.com/poweredgemanuals for detailed thermal restrictions.

Thermal summary

Appendix B. Standards compliance

The system conforms to the following industry standards.

Table 27. Industry standard documents

Standard	URL for information and specifications
ACPI Advance Configuration and Power Interface Specification, v2.0c	https://uefi.org/specsandtesttools
Ethernet IEEE 802.3-2005	https://standards.ieee.org/
HDG Hardware Design Guide Version 3.0 for Microsoft Windows Server	microsoft.com/whdc/system/platform/pcdesign/desguide/serverdg.mspx
IPMI Intelligent Platform Management Interface, v2.0	intel.com/design/servers/ipmi
DDR4 Memory DDR4 SDRAM Specification	jedec.org/standards-documents/docs/jesd79-4.pdf
PCI Express PCI Express Base Specification Rev. 2.0 and 3.0	pcisig.com/specifications/pciexpress
PMBus Power System Management Protocol Specification, v1.2	http://pmbus.org/Assets/PDFS/Public/PMBus_Specification_Part_1_Rev_1-1_20070205.pdf
SAS Serial Attached SCSI, v1.1	http://www.t10.org/
SATA Serial ATA Rev. 2.6; SATA II, SATA 1.0a Extensions, Rev. 1.2	sata-io.org
SMBIOS System Management BIOS Reference Specification, v2.7	dmtf.org/standards/smbios
TPM Trusted Platform Module Specification, v1.2 and v2.0	trustedcomputinggroup.org
UEFI Unified Extensible Firmware Interface Specification, v2.1	uefi.org/specifications
USB Universal Serial Bus Specification, Rev. 2.0	usb.org/developers/docs

Appendix C Additional resources

Table 28. Additional resources

Resource	Description of contents	Location
Installation and Service Manual	This manual, available in PDF format, provides the following information: <ul style="list-style-type: none"> • Chassis features • System Setup program • System indicator codes • System BIOS • Remove and replace procedures • Diagnostics • Jumpers and connectors 	Dell.com/Support/Manuals
Getting Started Guide	This guide ships with the system, and is also available in PDF format. This guide provides the following information: <ul style="list-style-type: none"> • Initial setup steps 	Dell.com/Support/Manuals
Rack Installation Guide	This document ships with the rack kits, and provides instructions for installing a server in a rack.	Dell.com/Support/Manuals
System Information Label	The system information label documents the system board layout and system jumper settings. Text is minimized due to space limitations and translation considerations. The label size is standardized across platforms.	Inside the system chassis cover
Quick Resource Locator (QRL)	This code on the chassis can be scanned by a phone application to access additional information and resources for the server, including videos, reference materials, service tag information, and Dell EMC contact information.	Inside the system chassis cover
Energy Smart Solution Advisor (ESSA)	The Dell EMC online ESSA enables easier and more meaningful estimates to help you determine the most efficient configuration possible. Use ESSA to calculate the power consumption of your hardware, power infrastructure, and storage.	Dell.com/calc